

Flare
Pit

NOTES

Hole Center to:

First Pipe Rack	12.30m
Out to 2nd Rack	13.00m
Outside Water Tank	6.80m
Flare	36.45m
Mud Tank	8.00m
Sump	9.00m
End of Gen. Building	26.50m
Manifold Shack	24.65m
End of Catwalk	2.50m
Crown Stand	36.00m
Flare Pit	36.45m

Component List

Item No.	Description
1	Substructure
2	Mud Tanks
3	Dog House
4	Tool House & Water Tank
5	Mud Pump Houses
6	Generator Building
7	Catwalk
8	Manifold Shack
9	Pipe Racks
10	Sump
11	Hole Center
12	Drawworks

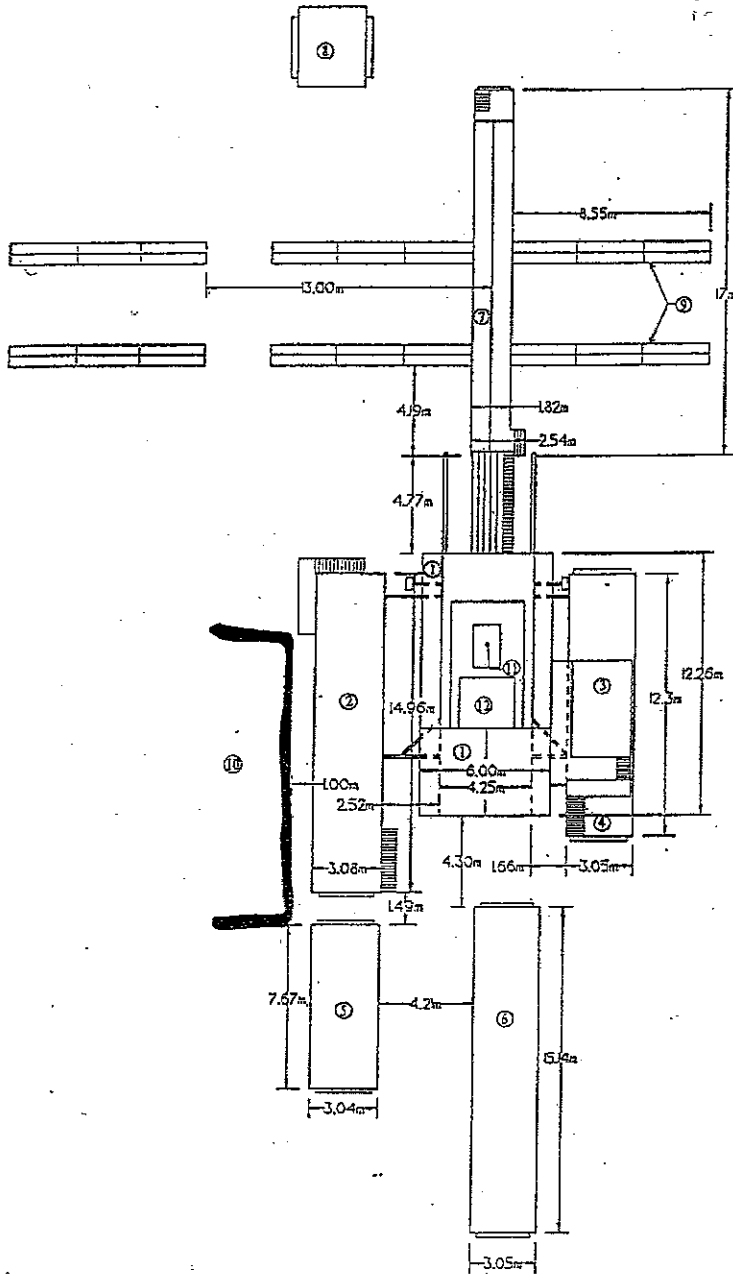



Terroco Drilling Ltd.

title:
Layout of Rig 5

drawn by: <i>M. Siford</i>	date: 08/04/95
app by:	sheet: 1 of 1
scale: 1 : 350	Page No.

CROWN STAND

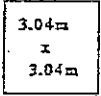

*36m from Hole
Center to Crown
Stand

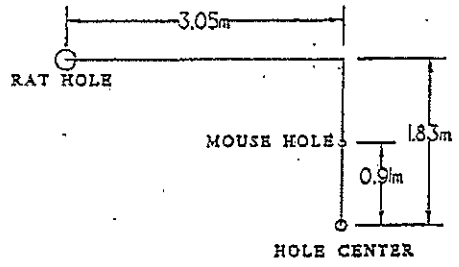

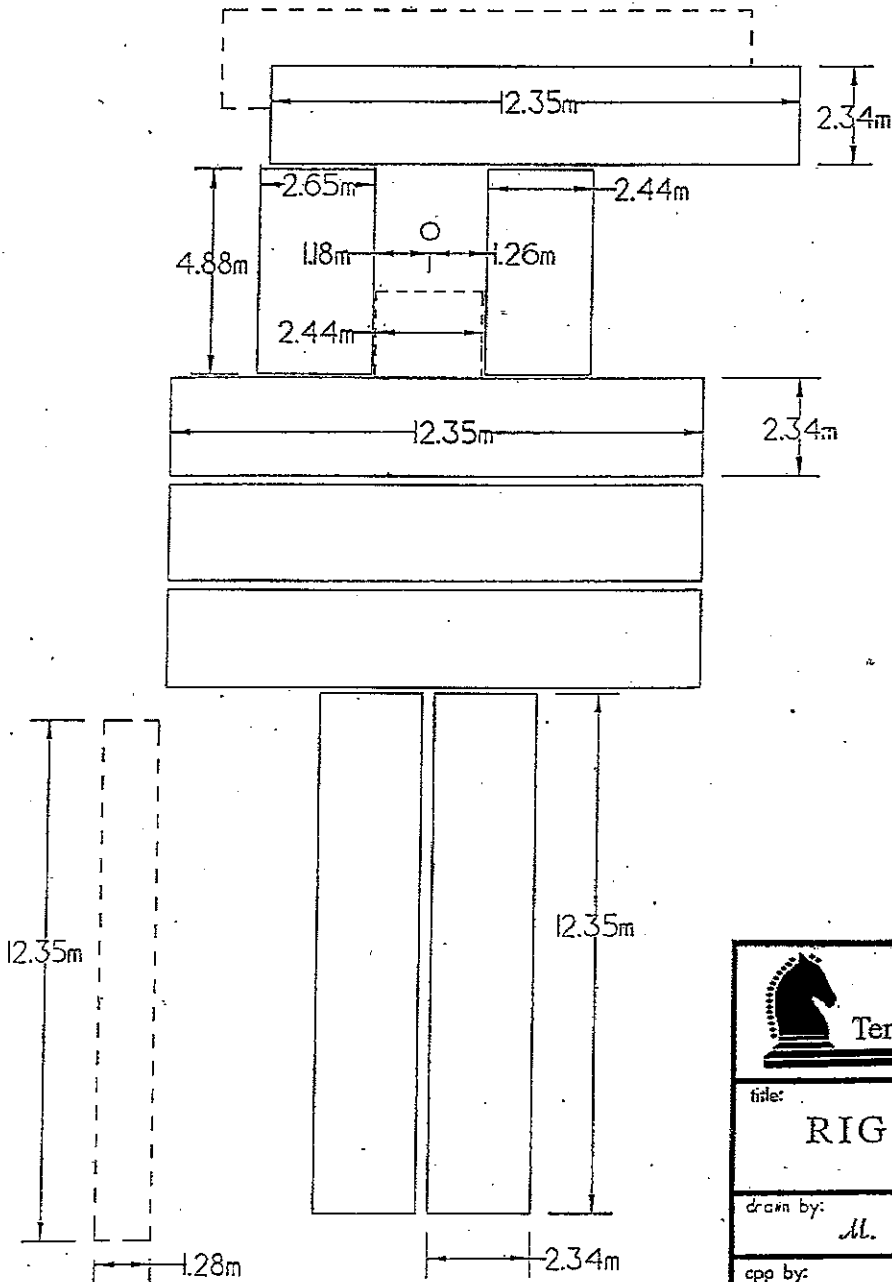

RAT HOLE: 8.51 m Deep
MOUSE HOLE: 3.59 m Deep

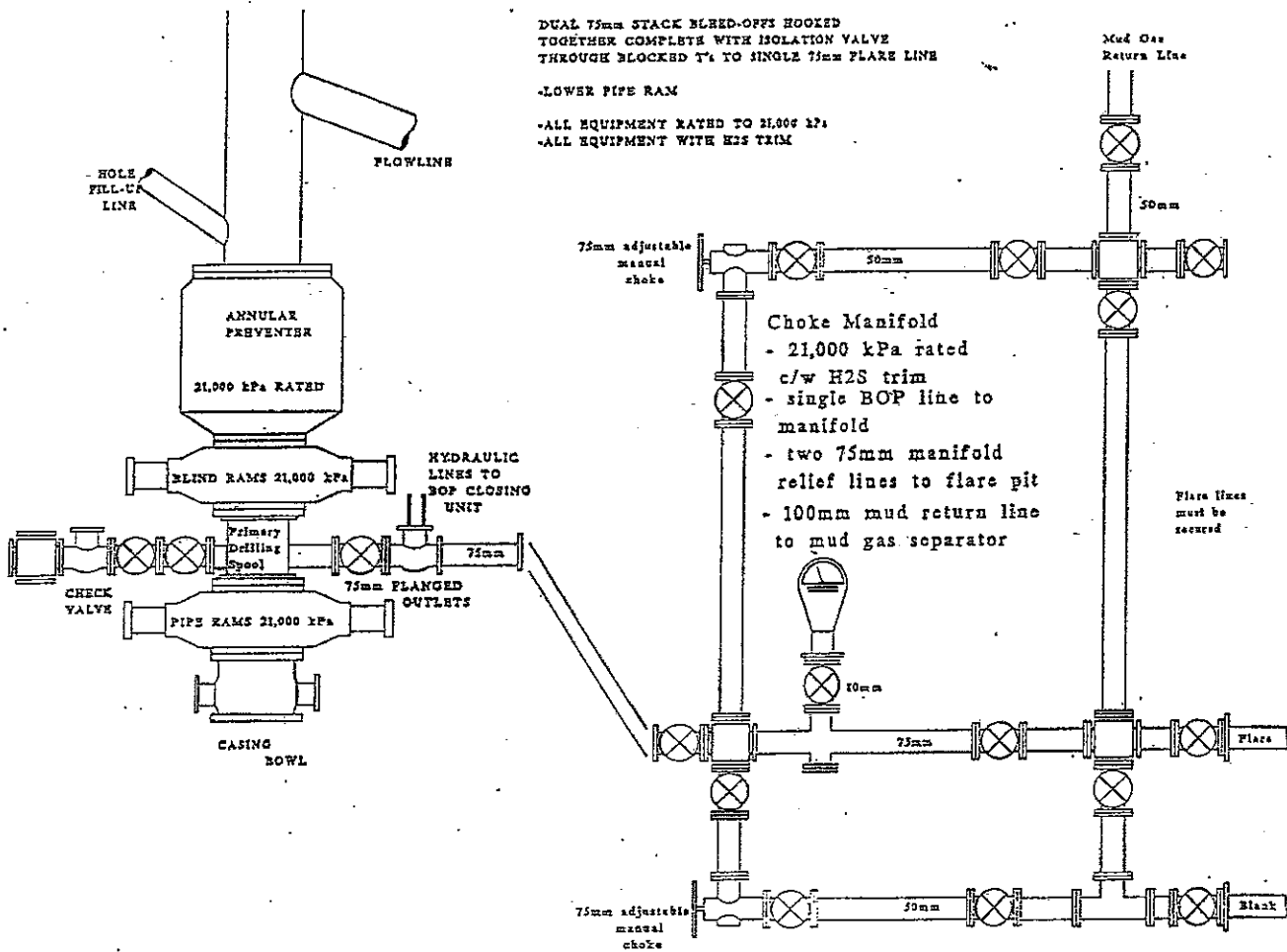

 Terroco Drilling Ltd.	
file: RIG 5 LAYOUT/ MATTING	
drawn by: <i>M. Piford</i>	date: 08/04/95
app by:	sheet: 1 of 1
scale: 1 : 250	Page No.

RIG #5 254mm (10") - 21,000 kPa (3,000 lb.)



 Terroco Drilling Ltd.	
Title: RIG 5 B.O.P. DIAGRAM	
drawn by: <i>M. Liford</i>	date: 08/08/95
app by:	sheet: 1 of 1
scale: N.T.S.	Page No.